

1.2T~1.6T
사용가능

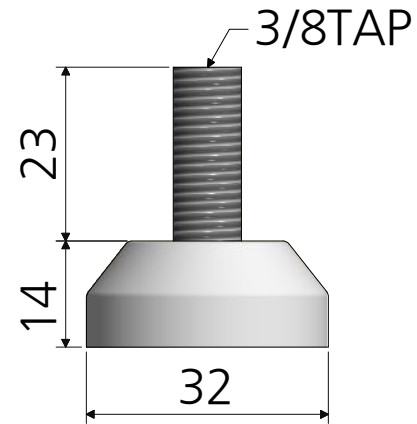
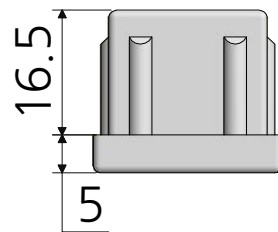
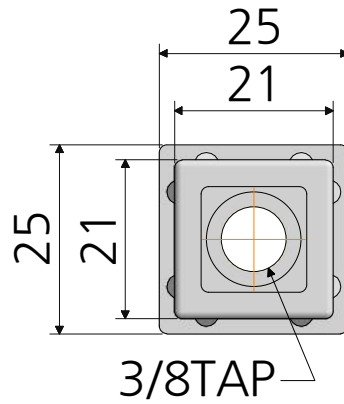

재질	플라스틱 / 철	품명	조절발 25
표면처리	-	품번	PR6-2525
명가장식철물			