

6 5 4 3 2 1

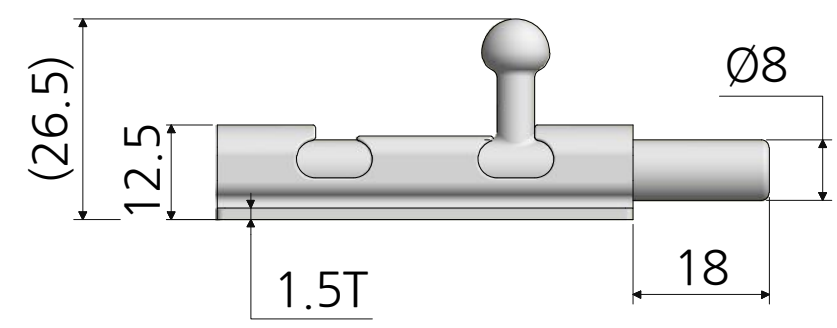
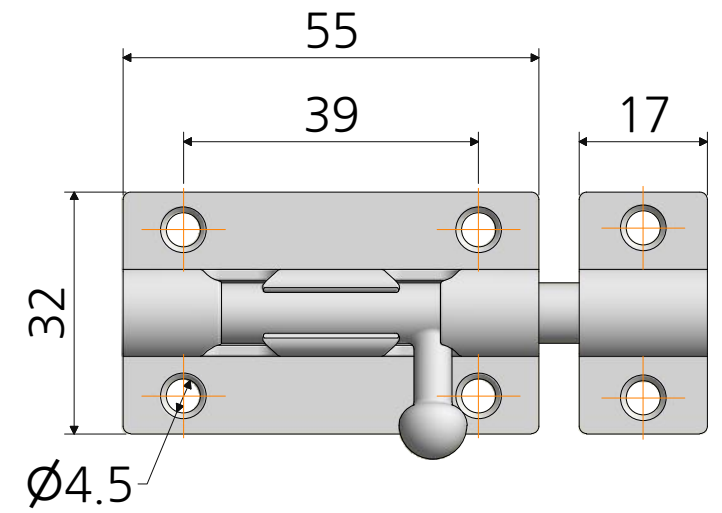

재질	스텐레스304	품명	스텐사각오도시 3인치
표면처리	-	품번	ODS1-3
명가장식철물			

6 5 4 3 2 1